



1328 Parkway Court • Beaver Creek • OH • 45432
Phone: (937) 426-2703 • Fax: (937) 426-1125 • E-Mail: info@NexSens.com
Visit us on the web at <http://www.NexSens.com>

**Stevens Water 93640, HydraProbe II
Soil Moisture Sensor
Sensor Interface Manual
Revision 07.10.12**

Table of Contents

Keeping iChart Up to Date	2
Technical.....	3
Understanding the Concept.....	3
Wiring	4
Pre-iChart Setup.....	5
Adding to iChart	7
Changing SDI-12 Addresses.....	16
Troubleshooting SDI-12 Communication.....	18
Multiple SDI-12 Sensors.....	21

About NexSens Technology, Inc.

NexSens software and real-time data logging systems are designed to simplify the setup and operation of environmental monitoring networks. NexSens products automate much of the tedious programming, data collection, and manual data processing common with other systems.

iChart is an easy-to-learn, easy-to-use Windows-based software program designed to interface with the industry's most popular environmental monitoring sensors and systems. A large multi-vendor instrument library makes setup quick and easy. iChart automates much of the tedious programming, data collection and manual data processing common with other environmental data collection systems.

The NexSens iSIC (Intelligent Sensor Interface and Control) is a state-of-the-art line of data loggers that simplify the collection of real-time data from environmental sensors and monitoring instruments. The iSIC data logger supports multi-vendor sensor connections and is designed for environmental data monitoring with NexSens communication equipment and software.

How to Use This Manual

This manual is designed to provide you with detailed instructions for interfacing specific sensors to the NexSens iSIC data logger.

This manual provides you with all the information needed to interface your sensor with the iSIC data logger. For advanced system and sensor reference material:

- Review the material in the iSIC operations manual:
 - <http://www.nexsens.com/support/manuals.htm>
- Review the sensor manufacturer's operations manual. This information should have been provided with the purchase of the sensor. This material can also typically be found at the instrument manufacturer's website. If you are still having difficulty, email your technical support question to:
support@nexsens.com

Keeping iChart Up to Date

NexSens periodically releases new versions of iChart software and iSIC firmware to be downloaded free of charge. The updated versions typically add new features, improve existing features, and/or add more reliability to the system. It is important that iChart is updated to the latest version before connecting a new sensor to your iSIC data logger. Your computer will require internet access to update automatically.

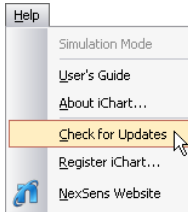

To obtain the latest version of iChart software, open the program on your computer. In the **Help** menu, select **Check for Updates**.

If your software is up to date, iChart will confirm that your computer is running the current software release.

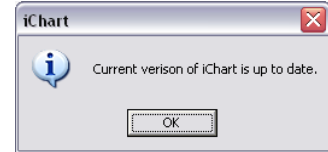

If a newer version of iChart is available, a dialog box will appear asking if you would like to upgrade to download the update.

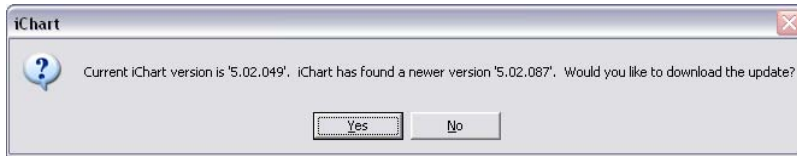

Click **Yes**. iChart will begin downloading the update.

Note: Depending on your connection speed, this update may take a few minutes. You can continue running other applications on your computer while the download is progressing.

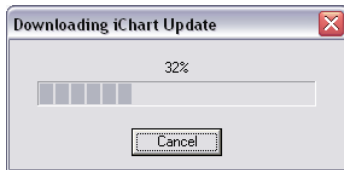

When the update has finished the downloading process, click **OK** and close iChart.

Reopen iChart. When the program opens, iChart will automatically begin the installation process. Follow the step-by-step installation windows to complete the iChart software update.

Note: If an internet connection is unavailable on the computer, iChart can be downloaded onto another computer and then moved to the computer where it needs installed. The latest version of iChart can be downloaded here:

<http://www.nexsens.com/support/downloads.htm>

Technical

SDI-12 is a data communications protocol developed specifically for water monitoring applications. The motivation to develop SDI-12 began in the 1980's when a group of environmental monitoring specialists started to become frustrated with the complexity of interfacing analog sensors with the dataloggers of the time. In addition, these low-power analog sensors were extremely unreliable. A goal was set to develop a protocol that would address and solve these frustrations.

The Serial Digital Interface Protocol (SDI-12) was the solution to the environmental monitoring specialists needs. SDI-12 governs exactly how a sensor must communicate with a datalogger. Any sensor claiming to be SDI-12 compatible must accept a standard set of commands and conform to specific electrical and power standards. SDI-12 sensors are "smart" sensors. They contain specialized circuitry and programming to enable users to configure and calibrate the sensor completely independent of a datalogger.

There are a number of advantages to using SDI-12 sensors over classic analog monitoring devices.

- ❑ The SDI-12 digital signal is low-power and resistant to data errors.
- ❑ The sensor's analog signal is converted to digital in the sensor, not the datalogger.
- ❑ Use of digital signals greatly reduces the effects of noise interference.
- ❑ Instantly plug-in or unplug sensors from the system.

Understanding the Concept

It is important to understand how SDI-12 sensors work. Sensors that adhere to SDI-12 protocol have a subset of commands that are consistent with every other SDI-12 sensor. These commands are used to identify the instrument, start a measurement, get data, etc.

The way a datalogger works when an SDI-12 sensor is connected to it, is that at a user specified interval (the log or sample interval), the datalogger sends the measurement command to the instrument. The SDI-12 sensor will then start taking a measurement and let the datalogger know when it will be done doing so. When the sensor has finished taking a measurement the data logger will ask the sensor for the data.

The sensor will return its data in a data string. This string will look something like this:

0+79.5+0.008+0.988+0.92

With each parameter separated by a plus sign.

One thing SDI-12 protocol does not do is tell the user what parameter and unit of measurement each returned value is. This information therefore has to be specified in the software. That is why it is important to know the exact order of parameters and the associated unit of measurement of each parameter returned.

Wiring

The Stevens Water HydraProbe II should be connected to an iSIC data loggers as follows:

- BLUE:** SDI12 data
- RED:** +12V power
- BLACK:** Ground

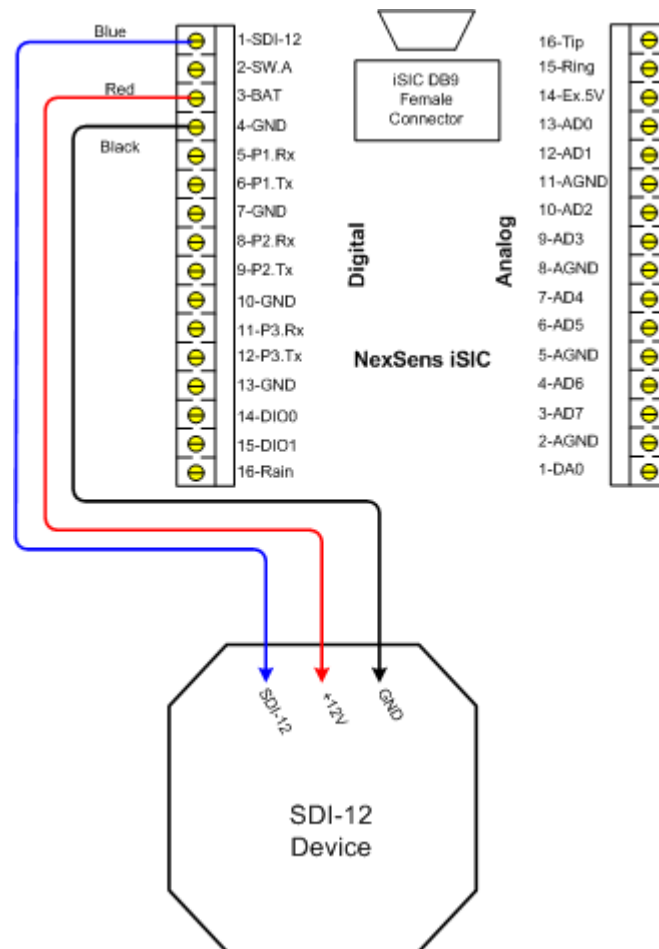

Multiple SDI-12 Sensors can be wired to the same digital terminal strip. See the following page for more information. Up to ten SDI-12 devices can be connected to the SDI-12 pin on the iSIC data logger.

Pre-iChart Setup

Before the Stevens HydraProbe can be used with a data logger it must be configured using SDI-12 commands.

In iChart, go to the **Advanced | iSIC | iSIC** menu. The **iSIC Setup** dialog box will open:

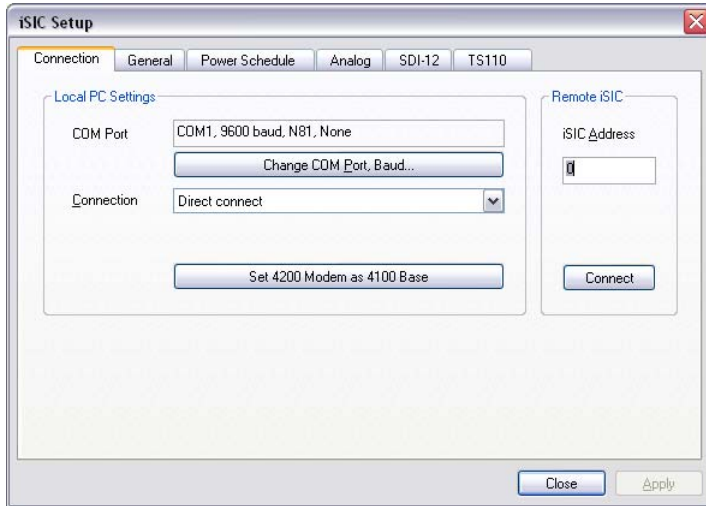

The first screen gives you the iSIC connection opens. Enter the COM port and connection method of the desired iSIC as well as the iSIC Address. For example, if you are trying to connect to a 2100-iSIC with a modem connected to COM3, select 2100-iSIC from the connection drop down menu, and COM3 from the COM port menu. The address will typically be '1' unless connecting to a 4100-iSIC. When this information has been correctly entered, click the **Connect** button.

After connecting click on the **SDI-12** tab and follow the steps on the following page to configure the Stevens SDI-12 Hydra probe:

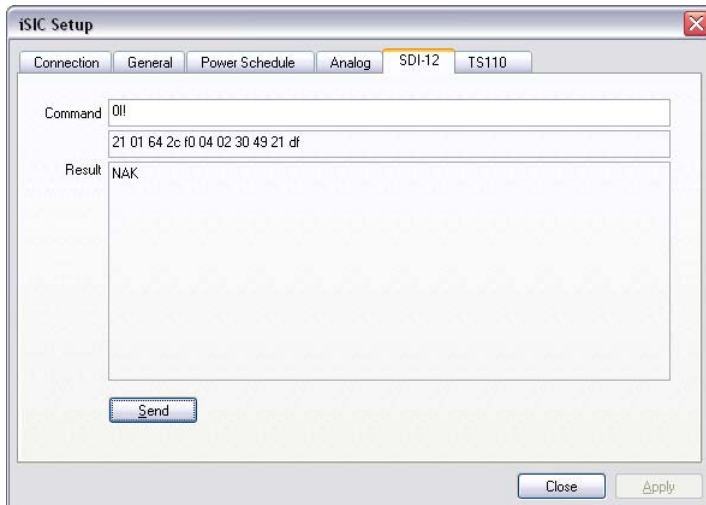

****To avoid confusion, only connect one SDI-12 sensor at a time during this setup****

1. First send the "0I!" command.

Verify that the probe is correctly connected.

2. Then send the probe parameter setup command "OXM=GHIJ!"

Setup the probe parameters. NOTE that this commands returns NAK. So we don't know if the command has been successfully executed or not. We will verify that in step 4 below. The parameters are as followed (in this order).

G: Soil Temperature (F)

H: Soil Moisture (unitless)

I: Soil Salinity (Grams NaCl/liter)

J: Soil conductivity temperature corrected (Siemens/meter)

3. Then send "OXS<SoilType>!", where <SoilType> is listed below

Setup soil type. The <SoilType> is 1, 2, or 3.

1: sand

2: silt

3: clay

4. Then send "0M!"

Start a measurement. NOTE that the respond must be 00024. If the last digit is not 4, go back and repeat step 2 then execute this step again.

where 0: probe address

002: number of seconds the probe takes to complete the measurement.

4: number of parameters (temp, moisture, salinity, & conductivity)

Wait at least 3 seconds for the measurement to be completed.

5. After waiting the number of seconds the probe takes to complete a reading send "0DO!"

Get measurement result. This command returns 3 readings: temperature, moisture, and salinity.

6. Then send "0D1!"

Get additional measurement result. This command returns 1 reading, conductivity.

7. Then send "0A<NewAddress>!", where <NewAddress> is a number 1 to 9 that is not being used by any other SDI-12 sensor connected to this data logger

Change probe address from 0 to a new address. NewAddress must be from 1 to 9.

8. Then send "<NewAddress>I!" to verify the address change where <NewAddress> is the address used in step 7.

Verify new address.

Adding to iChart

Once all wiring is completed, the device is ready to be added to an iChart database. To add the device to an existing database, select **Instrument | Add Device**. To create a new database, select **File | New Project**.

Setup Device Wizard

The Setup Device Wizard will begin. Click **Next** to continue.

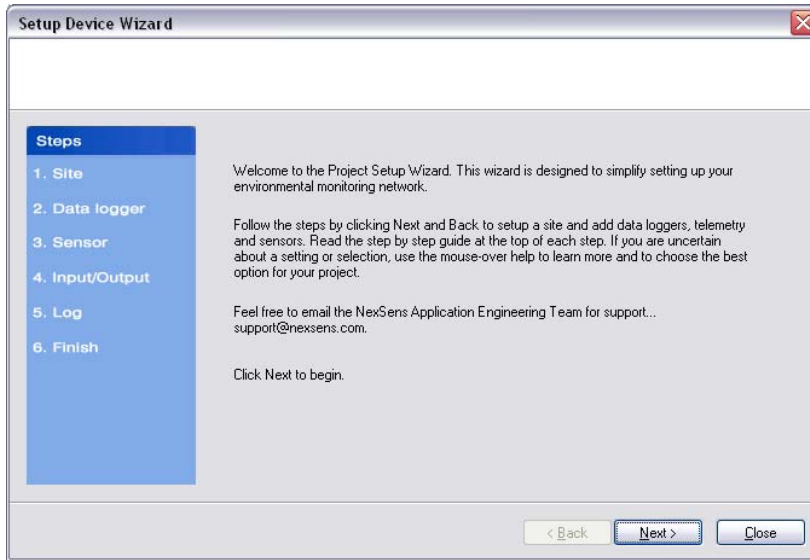

Step 1 – Site Setup

The first step is to create a site for data loggers and sensors to be located in. If this is an existing project, sites may already exist. Enter a **Site Name** and click **Add**.



Step 2 – Data Logger & Telemetry

The next step is to add the data logger(s) to the sites created in the previous step. Select a site to add a data logger to. Then select the data logger model number from the list at right and click **Add**.

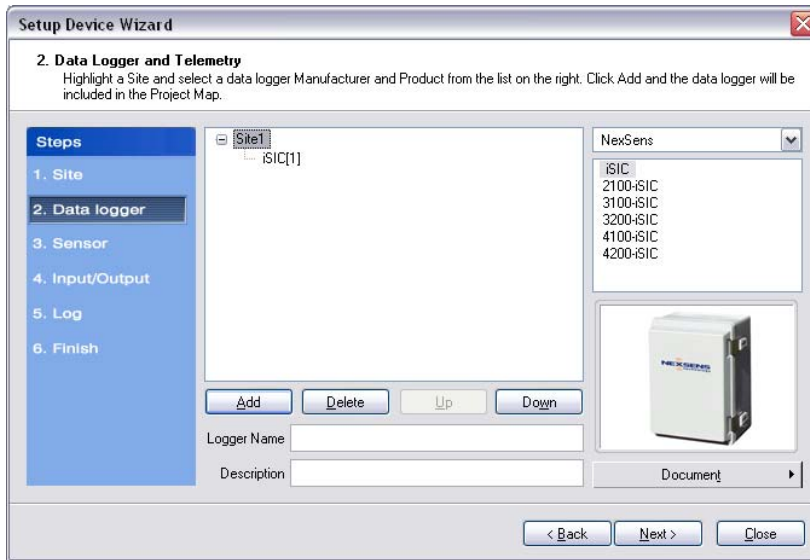

The **iSIC Data Logger Communication Properties** dialog box will appear. Enter the required iSIC data logger connection information (see below for model-specific instructions) to finish adding the data logger to the selected site. When complete, click **OK**.

For an **iSIC** data logger, enter the iSIC address and select the PC COM Port that the data logger is connected to.

- The iSIC address is typically '1'. If unknown, enter '0' and click **Test Connection** to determine the address.
- The PC COM Port drop-down menu is the list of available COM ports iChart detected on the computer.

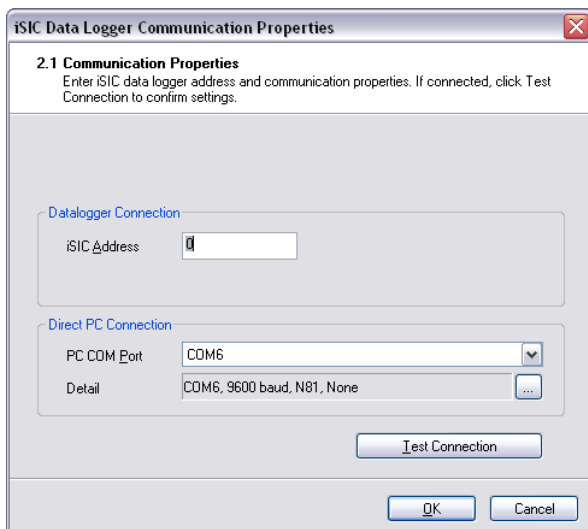

For a **2100-iSIC**, enter the 2100-iSIC address, phone number, and PC COM Port that the computer phone modem is connected to.

- The 2100-iSIC address is typically '1'. If unknown, enter '0' and click **Test Connection** to determine the address.
- The PC COM Port drop-down menu is the list of available COM ports iChart detected on the computer. Internal PC phone modems are typically set to COM3.

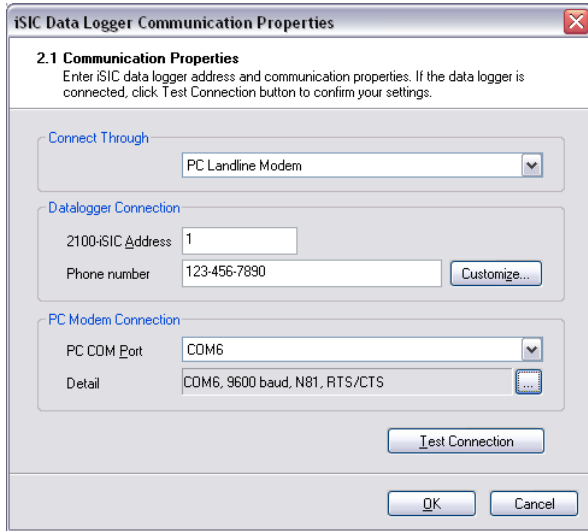

For a **3100-iSIC**, enter the 3100-iSIC address and the IP address of the data logger.

- The 3100-iSIC address is typically '1'. If unknown, enter '0' and click **Test Connection** to determine the address.
- The IP address is provided by the cellular service provider in which your cellular data account is setup. The port is set to 500 by default.

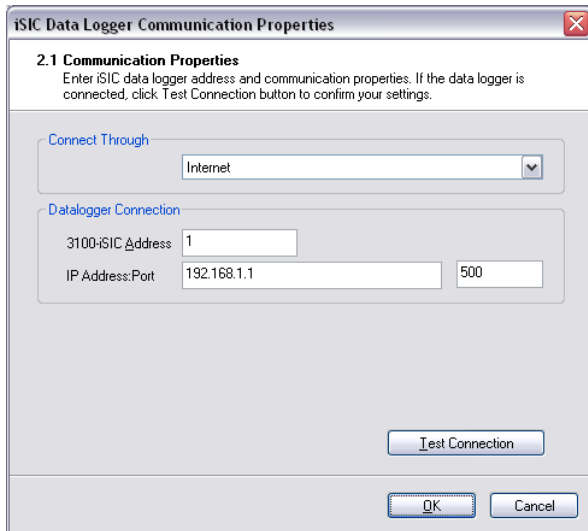

For a **4100-iSIC**, select the method in which the 4100-iSIC is connected to your PC and enter the 4100-iSIC address.

- A 4100-iSIC can connect to a PC through a 4100-BASE or a 4200-iSIC.
 - A 4100-BASE system connects to a PC via RS-232 cable.
 - A 4200-iSIC connects to a PC via landline telephone.
- The 4100-iSIC address is '1' by default.
 - If there is more than one 4100-iSIC in use, each 4100-iSIC should be programmed with different addresses (See the *4100-iSIC / iSIC Addressing* section in the iSIC manual).

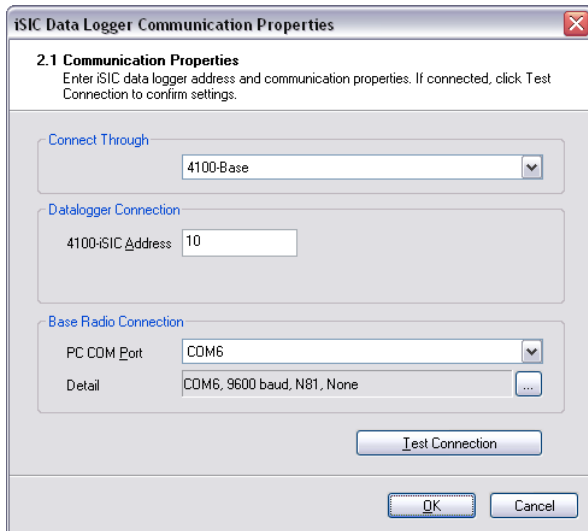

For a **4200-iSIC**, enter the iSIC address and PC COM port the data logger is connected to.

- The 4200-iSIC address is typically 250. When communicating with a 4200-iSIC, any communication using the 4200-iSIC address will be sent to the 4200-iSIC data logger.
 - Communications using any other address will be broadcast to any 4100-iSIC(s) in your radio network.
- Note:** Do not use address '0' when communicating to a 4200-iSIC.
- The drop down menu of PC COM Port's is the list of available COM ports iChart detected on the computer. Internal phone modems are typically set to COM3.

Step 3 – Sensor

After selecting a data logger, click **Next** and select **Stevens Water** from the drop-down list of manufacturers. Then select the **93640, HydroProbe II** model and click **Add**.

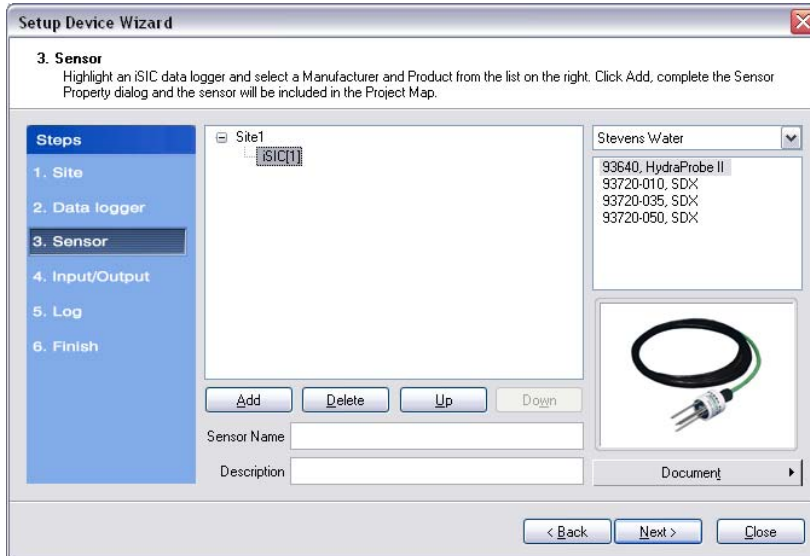

The **Sensor Properties** dialog box will come on the screen. Move the **Available Parameter** column into the **Selected Parameter** column in the order the parameters are returned with the unit of measurement they are returned with.

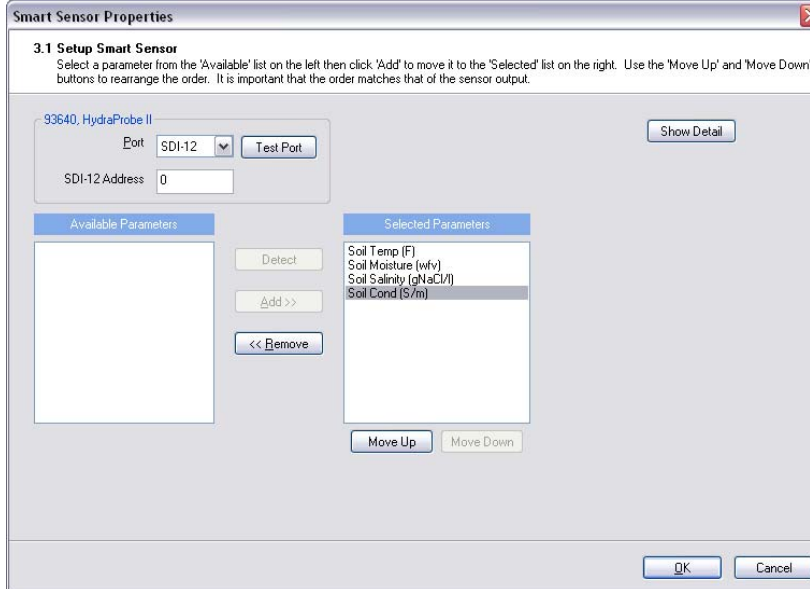

For example, if the setup from the beginning of this manual was followed the order would be:

- Soil Temp (F)
- Soil Moisture (wfv)
- Soil Salinity (gNaCl/l)
- Soil Cond (S/cm)

Enter the SDI-12 Address specified in the <NewAddress> field during the pre-iChart setup.

*****Make sure the Pre-iChart Setup procedure is followed prior to setup*****

Click **OK** and the sensor will be added to the selected data logger. More sensors can be added at this time by selecting the sensor manufacturer and then sensor model number from the drop down menu on the right. Click **Next** when finished adding sensors.

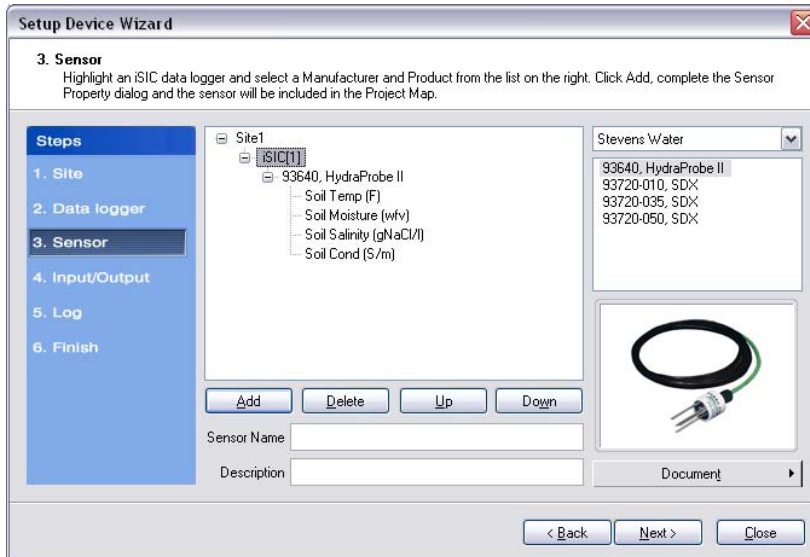

Step 4 – Input/Output

Enable any output and control features of the data logger. See the iSIC manual, section **4.4.2 iSIC Controls** for more information on this functionality.

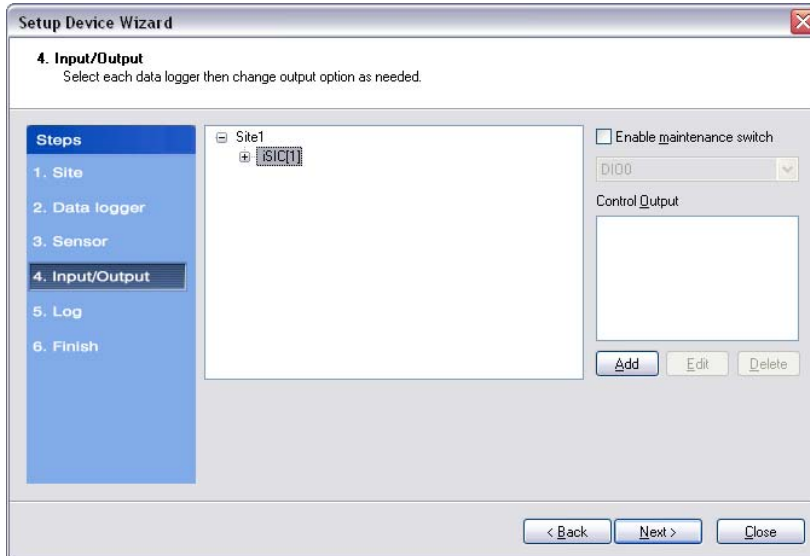

Step 5 – Log

Select each data logger from the site list and enter the desired **Log Interval** and **Sample Interval** for the data logger in the **Interval** section. In the **Log Value** section, select how the data logger should log data points.

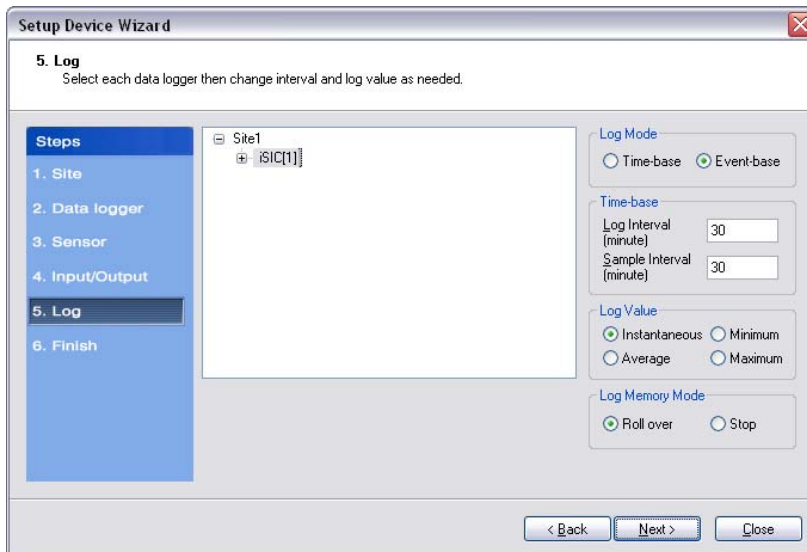

Log Mode

The Log Mode controls when data is logged by an iSIC. In **Time-base** (the default and most common), data is logged at a specified interval, controlled in the **Time-base** section. In **Event-base** log mode, data is only logged when a ground pulse is sent to the Rain input pin on the iSIC digital terminal strip (such as from the contact closure of a tipping bucket rain gauge).

Log Value

By default, the **Sample Interval** and **Log Interval** are equal. When a sampling interval is different than the log interval, all the sampled measurements for the iSIC are used to calculate the average, minimum, or maximum of that logging interval (based on the log type selected, only one can be selected at a time). The individual data points that comprise the samples are not saved; only the final, average, minimum or maximum data point is saved at the specified log interval.

Log Memory Mode

The default memory mode is **Roll over**, and is the recommended operating mode. In this mode, the last ~150K readings (when using 512K flash) will be stored in iSIC memory. When the iSIC memory has filled with readings it will “roll over” the original readings and keep logging. This is ideal for real time applications, where data is being uploaded to a PC as

In **Stop** memory mode, the first ~150K readings (when using 512K flash) will be stored in the iSIC memory. When the iSIC memory has filled with readings, it will stop logging until memory is cleared. When operating in this mode, it is recommended that memory is cleared every time data is uploaded.

Step 6 – Finish

All data loggers and sensors must be programmed before data collection can begin.

- Select an iSIC data logger and click the '**Program iSIC**' button. Before programming an iSIC:
 - The iSIC must be powered and connected to the computer.
 - The 2100-iSIC must be powered and connected to a phone line.
 - The 3100-iSIC must be powered and have a cellular data account.
 - The 4100-iSIC must be powered and be able to communicate to the computer through a 4100-base or 4200-iSIC
 - The 5100-iSIC must be powered and be able to communicate to the computer over Ethernet.
- Click **Finish** when programming is complete.

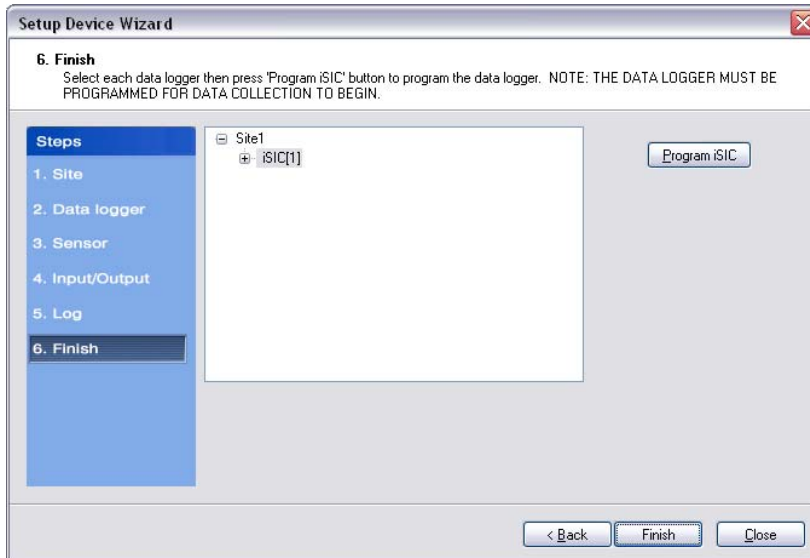

This wizard can always be revisited by selecting **Project | Setup Device Wizard** if you would like to program an iSIC at a later time or need to setup other sites, data loggers, and sensors.

Step 7 – Retrieve an Initial Data Set and Use the Instrument Within iChart

After your sensor has been added to the database, the main instrument control screen will appear.

Important: All parameters are initially displayed with blank values until after the first log interval has passed and data has been interrogated. Once data has been retrieved from the iSIC, these fields will show the most recent data set recorded by the instrument. By default, iChart will automatically interrogate devices five minutes after every hour.

Changing SDI-12 Addresses

Before multiple SDI-12 sensors can be used with a data logger they must each be configured to use a different address using SDI-12 commands.

In iChart, go to the **Advanced | iSIC | iSIC** menu. The **iSIC Setup** dialog box will open:

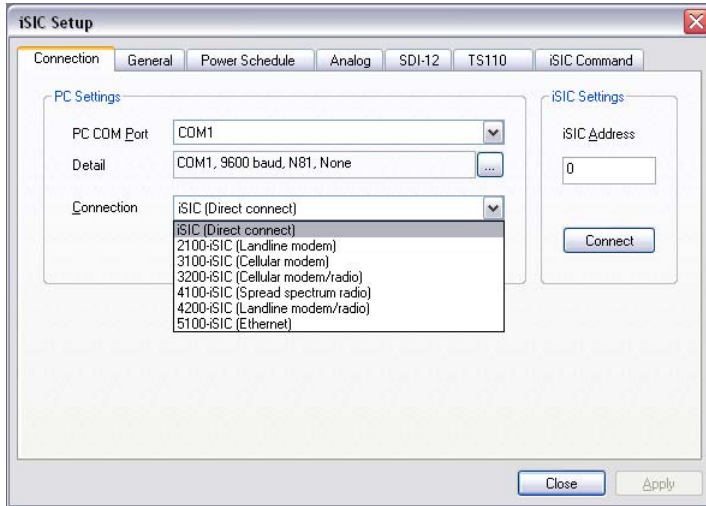

The first screen gives you the iSIC connection opens. Enter the COM port and connection method of the desired iSIC as well as the iSIC Address. For example, if you are trying to connect to a 2100-iSIC with a modem connected to COM3, select 2100-iSIC from the connection drop down menu, and COM3 from the COM port menu. The address will typically be '1' unless connecting to a 4100-iSIC. When this information has been correctly entered, click the **Connect** button.

After connecting click on the **SDI-12** tab and follow the steps on the following page to configure the SDI-12 sensor:

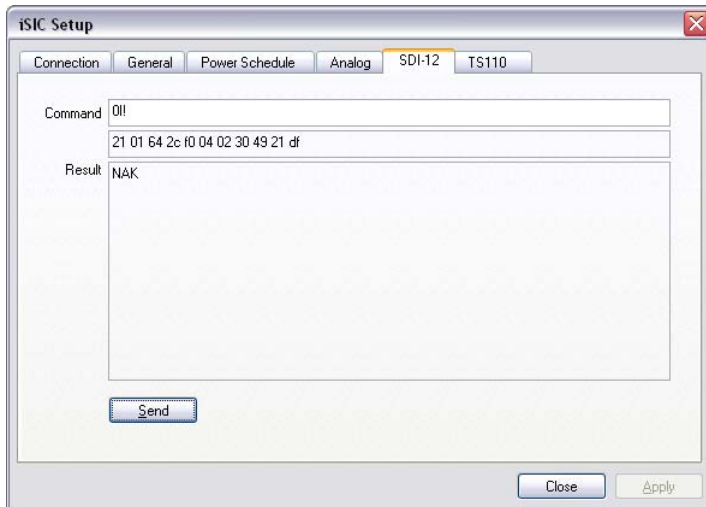

To avoid confusion, only connect one SDI-12 sensor at a time during this setup

9. First make sure the only SDI-12 sensor connected to the iSIC data logger is the SDI-12 sensor you want to change the address on.

This is to avoid accidentally changing the wrong SDI-12 sensor or changing this sensor to an SDI-12 address that already exists.

10. Then send the “?!” command.

The sensor will return **n<cr><lf>** where **n** is a number 0-9 and represents the current address. If a **NAK** is returned the sensor may not be correctly wired or correctly operating in SDI-12 mode as the iSIC cannot communicate to it via SDI-12.

If **Failed sending command** is returned, click on the general tab. Make sure you can communicate with the data logger. If not, see the data logger communication troubleshooting sections in the iSIC manual for the corresponding data logger trying to be connected.

11. Next send the “OI!” command.

Verify that the SDI-12 sensor is correctly connected. Replace **O** with the current SDI-12 address if a different one was returned by ?!.

12. Then send “OA<NewAddress>!”, where <NewAddress> is a number 1 to 9 that is not being used by any other SDI-12 sensor that will be connected to this data logger

Change probe address from 0 to a new address. NewAddress must be from 1 to 9. Replace **O** with the current SDI-12 address.

13. Then send “<NewAddress>I!” to verify the address change where <NewAddress> is the address used in step 4.

Verify new address.

****It is recommended that the sensor is now tagged with the SDI-12 address it was just set to make it easy to distinguish in the future****

Troubleshooting SDI-12 Communication

If SDI-12 data is displayed as -100000 in their native units it indicates that there is SDI-12 communication problem between the data logger and the SDI-12 sensor. In this situation, there are 3 possibilities.

1. Loose wiring between the logger and sensor
2. The sensor is not functioning correctly
3. The data logger SDI-12 interface is not functioning correctly

Loose wiring:

Verify all cable connections and wiring according the sensor interface manuals located here:

<http://www.nexsens.com/support/manuals.htm>

Make sure all connections are securely made and that the sensor is powered.

Checking whether the sensor/data logger is functioning:

In iChart, go to the **Advanced | iSIC | iSIC** menu. The **iSIC Setup** dialog box will open:

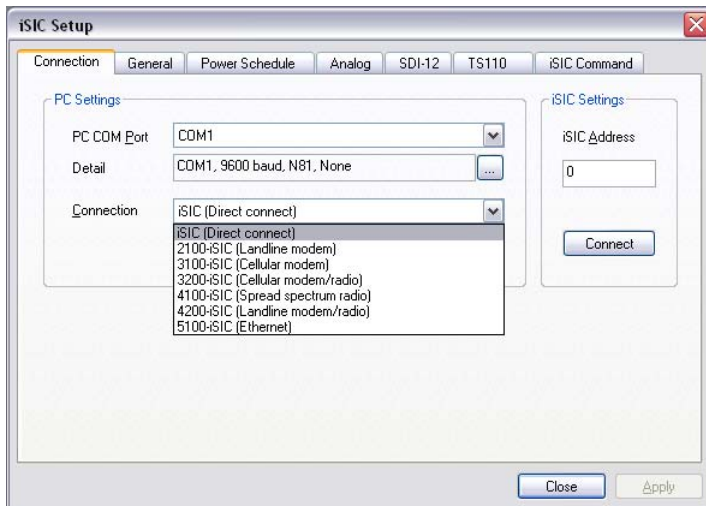

The first screen gives you the iSIC connection opens. Enter the COM port and connection method of the desired iSIC as well as the iSIC Address. For example, if you are trying to connect to a 2100-iSIC with a modem connected to COM3, select 2100-iSIC from the connection drop down menu, and COM3 from the COM port menu. The address will typically be '1' unless connecting to a 4100-iSIC. When this information has been correctly entered, click the **Connect** button.

After connecting click on the **SDI-12** tab and follow the steps on the following page to configure the SDI-12 sensor:

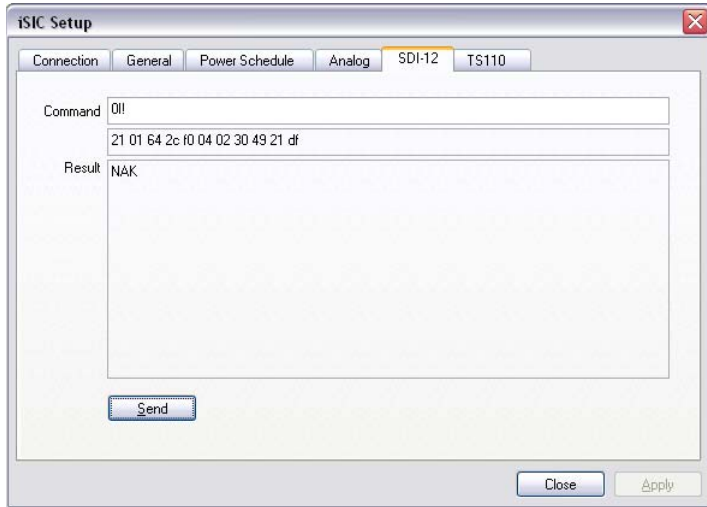

1. **First make sure the only SDI-12 sensor connected to the iSIC data logger is the SDI-12 sensor you want to change the address on.**

This is to avoid accidentally changing the wrong SDI-12 sensor or changing this sensor to an SDI-12 address that already exists.

2. **Then send the “?!” command.**

The sensor will return **n<cr><lf>** where **n** is a number 0-9 and represents the current address. If a **NAK** is returned the sensor may not be correctly wired or correctly operating in SDI-12 mode as the iSIC cannot communicate to it via SDI-12.

If **Failed sending command** is returned, click on the general tab. Make sure you can communicate with the data logger. If not, see the data logger communication troubleshooting sections in the iSIC manual for the corresponding data logger trying to be connected.

3. **Next send the “0!” command.**

Verify that the SDI-12 sensor is correctly connected. Replace **0** with the current SDI-12 address if a different one was returned by ?!.

4. **Next send the “0M!” command.**

You should see the respond back from the SDI-12 sensor. Wait for the “seconds to wait” before proceeding. Verify the number of parameters returned matches the number of parameters listed in iChart for this sensor. Replace **0** with the current SDI-12 address if a different one was returned by ?!.

The format:

<address><seconds to wait><number of parameters><cr><lf>

Both the address and number of parameters will be single digit numbers.

5. **Next send the “0D0!” command.**

You should see the respond back from the SDI-12 sensor. The response will be the data values separated by '+' signs. If not all parameters are returned, send "0D1!". Replace **0** with the current SDI-12 address if a different one was returned by ?!.

If you are unable to communicate with the SDI-12 sensor at this point, the only way to diagnose the issue further is to try the sensor on another known working data logger to see if it can communicate with the sensor, and to try a known working sensor on the data logger.

If this is not feasible contact NexSens for returns.

Multiple SDI-12 Sensors

Up to ten SDI-12 sensors may be connected to the iSIC Datalogger. It is recommended that multiple SDI-12 sensors be connected in a “daisy-chain” fashion inside a separate junction box.

Each sensor must have a unique SDI-12 address. For example, the first SDI-12 sensor could be set to Address 0. The next sensor should be Address 1.

