



1328 Parkway Court • Beaver Creek • OH • 45432  
Phone: (937) 426-2703 • Fax: (937) 426-1125 • E-Mail: [info@NexSens.com](mailto:info@NexSens.com)  
Visit us on the web at <http://www.NexSens.com>

**GP50 311 Pressure Sensor  
Sensor Interface Manual  
Revision 07.10.24**

# Table of Contents

Keeping iChart Up to Date.....	1
Technical .....	2
Wiring.....	3
Adding to iChart.....	4

## About NexSens Technology, Inc.

NexSens software and real-time data logging systems are designed to simplify the setup and operation of environmental monitoring networks. NexSens products automate much of the tedious programming, data collection, and manual data processing common with other systems.

iChart is an easy-to-learn, easy-to-use Windows-based software program designed to interface with the industry's most popular environmental monitoring sensors and systems. A large multi-vendor instrument library makes setup quick and easy. iChart automates much of the tedious programming, data collection and manual data processing common with other environmental data collection systems.

The NexSens iSIC (Intelligent Sensor Interface and Control) is a state-of-the-art line of data loggers that simplify the collection of real-time data from environmental sensors and monitoring instruments. The iSIC data logger supports multi-vendor sensor connections and is designed for environmental data monitoring with NexSens communication equipment and software.

## How to Use This Manual

This manual is designed to provide you with detailed instructions for interfacing specific sensors to the NexSens iSIC data logger.

This manual provides you with all the information needed to interface your sensor with the iSIC data logger. For advanced system and sensor reference material:

- Review the material in the iSIC operations manual:
  - <http://www.nexsens.com/support/manuals.htm>
- Review the sensor manufacturer's operations manual. This information should have been provided with the purchase of the sensor. This material can also typically be found at the instrument manufacturer's website. If you are still having difficulty, email your technical support question to:  
[support@nexsens.com](mailto:support@nexsens.com)

## Keeping iChart Up to Date

NexSens periodically releases new versions of iChart software and iSIC firmware to be downloaded free of charge. The updated versions typically add new features, improve existing features, and/or add more reliability to the system. It is important that iChart is updated to the latest version before connecting a new sensor to your iSIC data logger. Your computer will require internet access to update automatically.

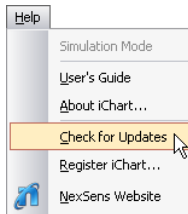

To obtain the latest version of iChart software, open the program on your computer. In the **Help** menu, select **Check for Updates**.

If your software is up to date, iChart will confirm that your computer is running the current software release.

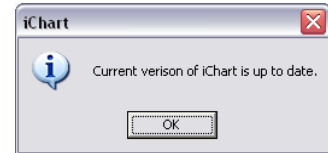

If a newer version of iChart is available, a dialog box will appear asking if you would like to upgrade to download the update.

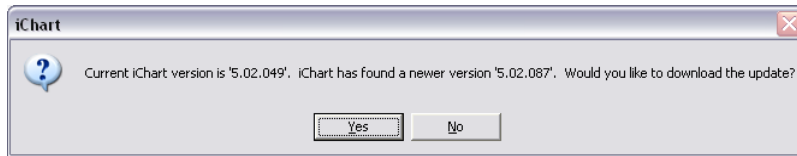

Click **Yes**. iChart will begin downloading the update.

**Note:** Depending on your connection speed, this update may take a few minutes. You can continue running other applications on your computer while the download is progressing.

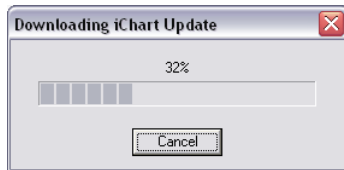

When the update has finished the downloading process, click **OK** and close iChart.

Reopen iChart. When the program opens, iChart will automatically begin the installation process. Follow the step-by-step installation windows to complete the iChart software update.

**Note:** If an internet connection is unavailable on the computer, iChart can be downloaded onto another computer and then moved to the computer where it needs installed. The latest version of iChart can be downloaded here:

<http://www.nexsens.com/support/downloads.htm>

## Technical

Industrial sensors commonly use a 4-20 mA DC signal. With this method, the sensor signal is conveyed as a current. Raw output of the sensor will either be 4 mA at the lowest or 20 mA at the highest. By examining the current between 4 and 20 mA an actual reading can be determined. For example, assume an air temperature sensor has a range of 0°C to 100°C. If the output from the temperature sensor is 4 mA, then the temperature is 0°C. If the output from the sensor is 20 mA, then the temperature is 100°C. Readings between 4 and 20 mA are linear and simple to determine. Dataloggers can be programmed to convert the electrical signal into the appropriate engineering units.

One of the major advantages of using 4-20 mA sensors is the limited signal loss of these devices. By outputting a sensor signal in the form of current, electrically noisy areas do not have an effect on the sensor's readings. Furthermore, accuracy is not affected by changes in line and connection resistance, or by the addition of other loads in the circuit.

## Wiring

Connect GP50 sensors to the analog and digital terminal strips. The GP50 311 is a loop powered analog sensor. A diagram of this is shown below:

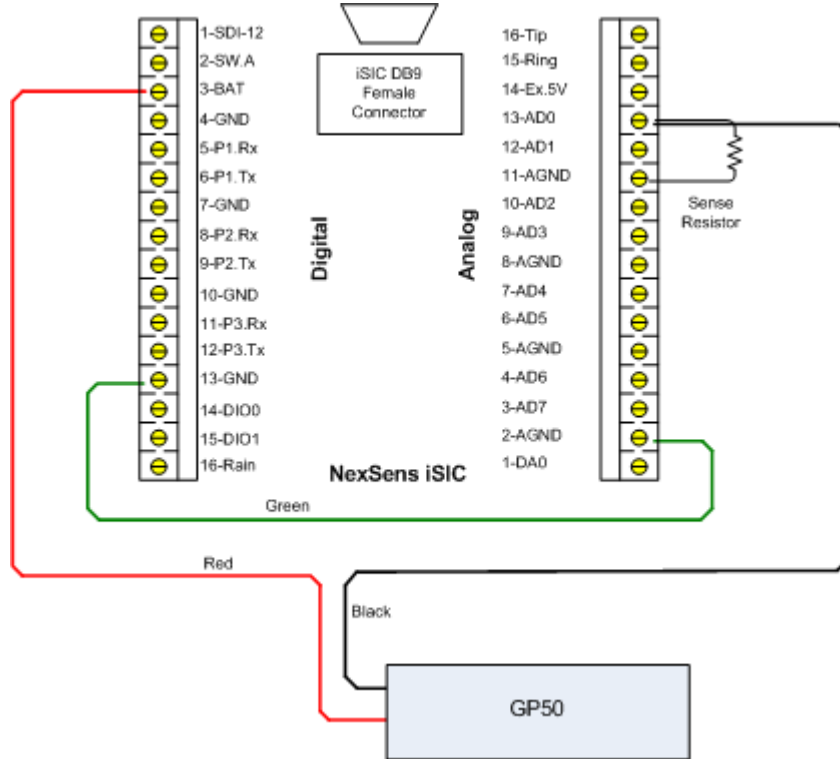

GP50 +Excit./Signal	Red	iSIC 3-BAT
GP50 -Excit./Signal	Black	iSIC 13-AD0
iSIC 13-GND	Green	iSIC 2-AGND
13-AD0	56 Ohm Resistor	11-AGND

Pins AD0 through AD7 can all be used for connecting 4-20 mA sensors. Eight 4-20 mA sensors can be connected at the same time using these pins on the analog terminal strip.

It is necessary for a sense resistor to be added into the wiring for each sensor to convert the current signal into a voltage signal. For your convenience, four 56Ω resistors are included with the iSIC. The included resistors have a ±1% accuracy. It is recommended you check the documentation for your particular sensor to find the exact resistor requirements.

**Note:** Do not wire more than one analog wire to each analog pin.

## Adding to iChart

Once all wiring is completed, the device is ready to be added to an iChart database. To add the device to an existing database, select **Instrument | Add Device**. To create a new database, select **File | New Project**.

### Setup Device Wizard

The Setup Device Wizard will begin. Click **Next** to continue.

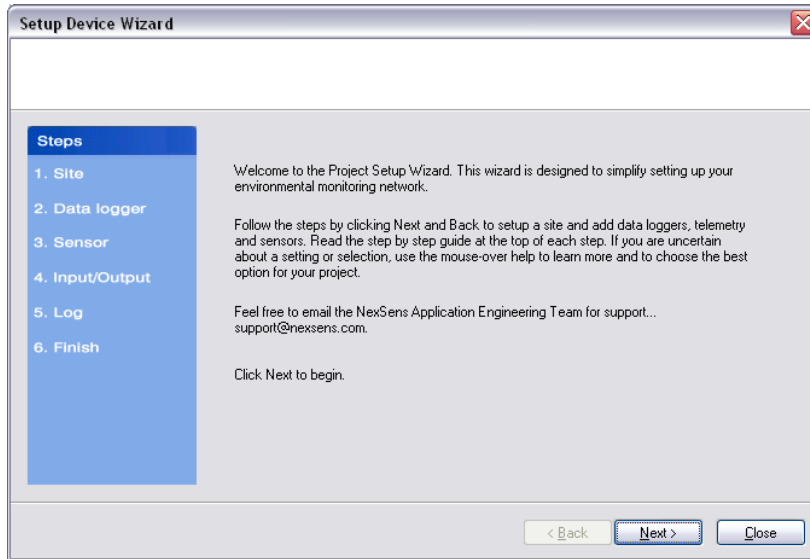

### Step 1 – Site Setup

The first step is to create a site for data loggers and sensors to be located in. If this is an existing project, sites may already exist. Enter a **Site Name** and click **Add** or simply select a site that has already been added from the navigation list.

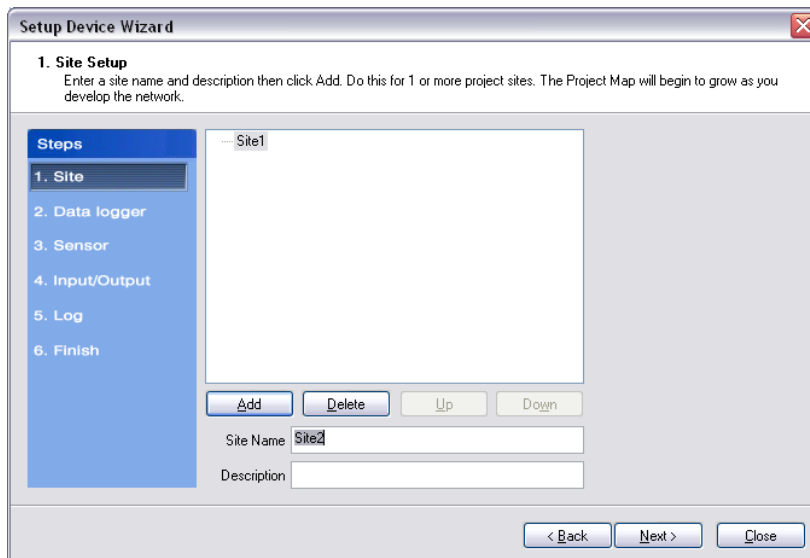

## Step 2 – Data Logger & Telemetry

The next step is to add the data logger(s) to the sites created in the previous step. Select a site to add a data logger to. Then select the data logger model number from the list at right and click **Add** or select a data logger that has already been added from the navigation list, if simply adding the sensor to a data logger that has already been setup.

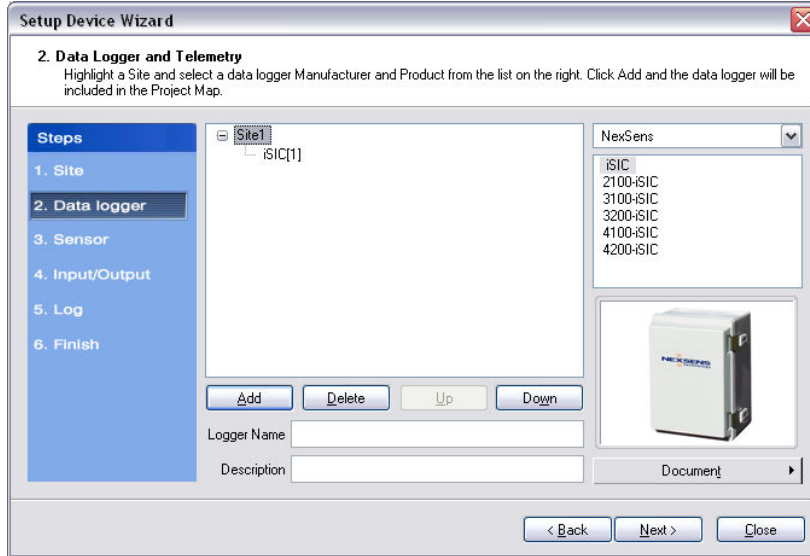

The **iSIC Data Logger Communication Properties** dialog box will appear. Enter the required iSIC data logger connection information (see below for model-specific instructions) to finish adding the data logger to the selected site. When complete, click **OK**.

For an **iSIC** data logger, enter the iSIC address and select the PC COM Port that the data logger is connected to.

- The iSIC address is typically '1'. If unknown, enter '0' and click **Test Connection** to determine the address.
- The PC COM Port drop-down menu is the list of available COM ports iChart detected on the computer.

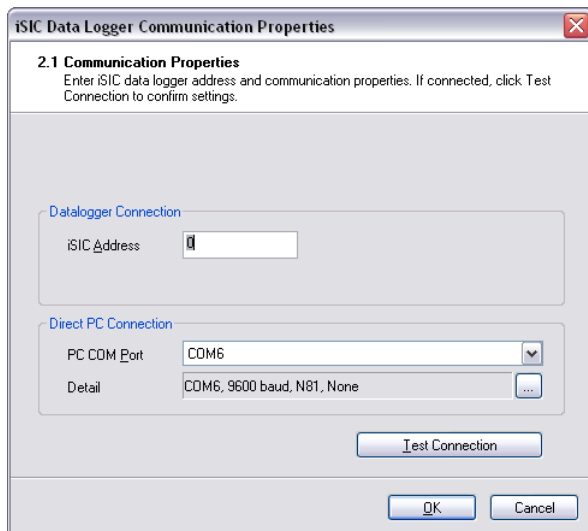

For a **2100-iSIC**, enter the 2100-iSIC address, phone number, and PC COM Port that the computer phone modem is connected to.

- The 2100-iSIC address is typically '1'. If unknown, enter '0' and click **Test Connection** to determine the address.
- The PC COM Port drop-down menu is the list of available COM ports iChart detected on the computer. Internal PC phone modems are typically set to COM3.

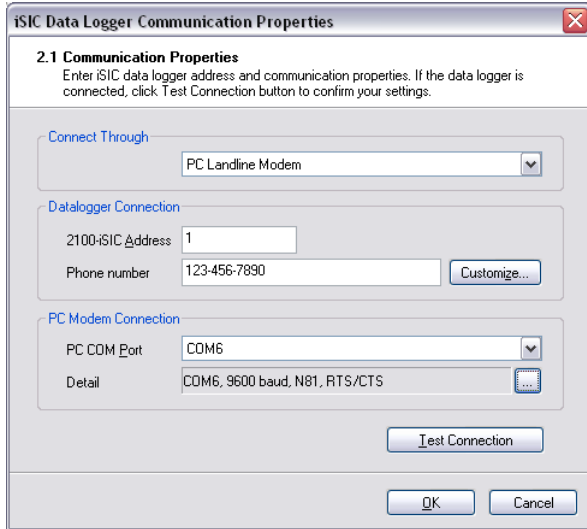

For a **3100-iSIC**, enter the 3100-iSIC address and the IP address of the data logger.

- The 3100-iSIC address is typically '1'. If unknown, enter '0' and click **Test Connection** to determine the address.
- The IP address is provided by the cellular service provider in which your cellular data account is setup. The port is set to 500 by default.

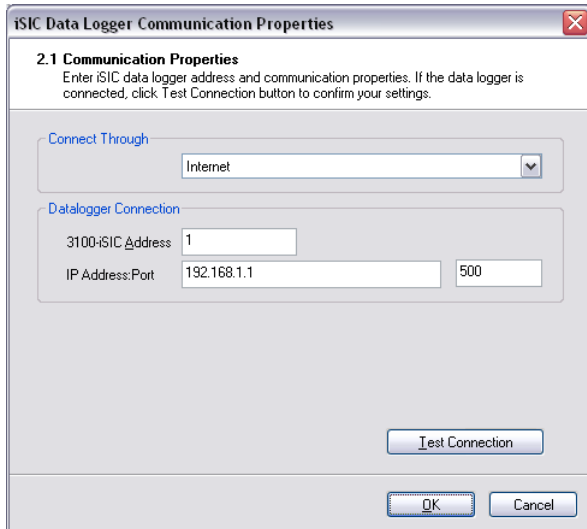

For a **4100-iSIC**, select the method in which the 4100-iSIC is connected to your PC and enter the 4100-iSIC address.

- A 4100-iSIC can connect to a PC through a 4100-BASE or a 4200-iSIC.
  - A 4100-BASE system connects to a PC via RS-232 cable.
  - A 4200-iSIC connects to a PC via landline telephone.
- The 4100-iSIC address is '1' by default.
  - If there is more than one 4100-iSIC in use, each 4100-iSIC should be programmed with different addresses (See the *4100-iSIC | iSIC Addressing* section in the iSIC manual).

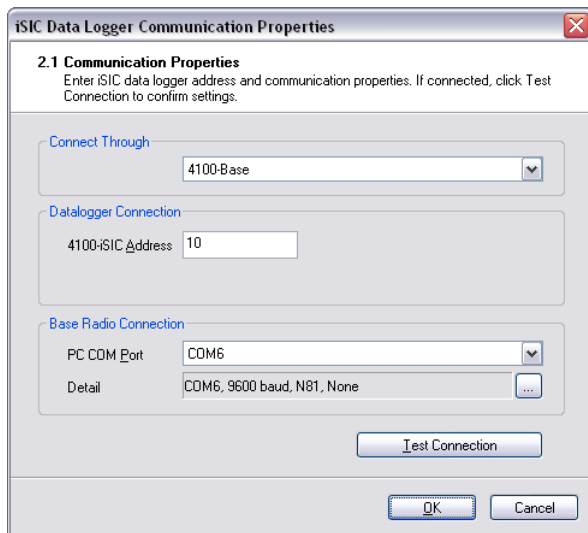

For a **4200-iSIC**, enter the iSIC address and PC COM port the data logger is connected to.

- The 4200-iSIC address is typically 250. When communicating with a 4200-iSIC, any communication using the 4200-iSIC address will be sent to the 4200-iSIC data logger.
  - Communications using any other address will be broadcast to any 4100-iSIC(s) in your radio network.
- **Note:** Do not use address '0' when communicating to a 4200-iSIC.
- The drop down menu of PC COM Port's is the list of available COM ports iChart detected on the computer. Internal phone modems are typically set to COM3.

### Step 3 – Sensor

After selecting a data logger, click **Next** and select **GP50** from the drop-down list of manufacturers. Then select **311** and click **Add**.

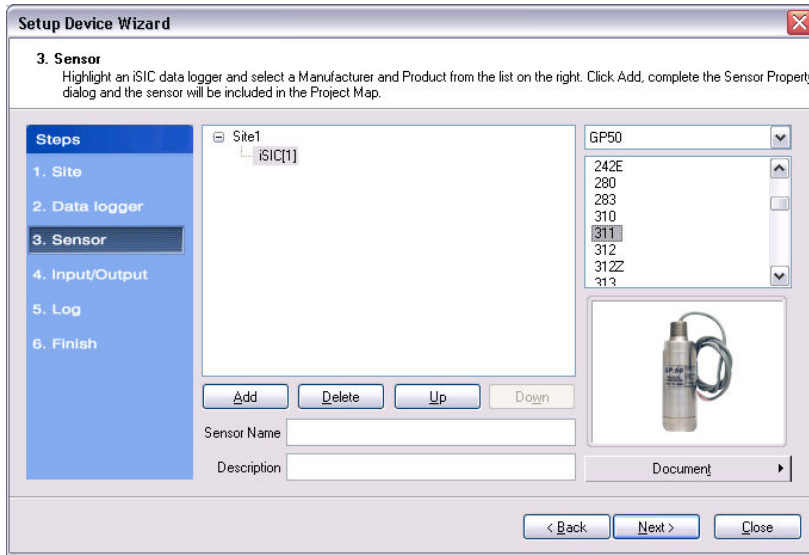

The **Sensor Properties** dialog box will come on the screen. From the **Analog Channel** drop-down menu, choose the channel the 4-20mA sensor is connected to. AD0 was used in the wiring diagram at the beginning of this manual. In the scaling enter the appropriate psi values for the 311 model number.

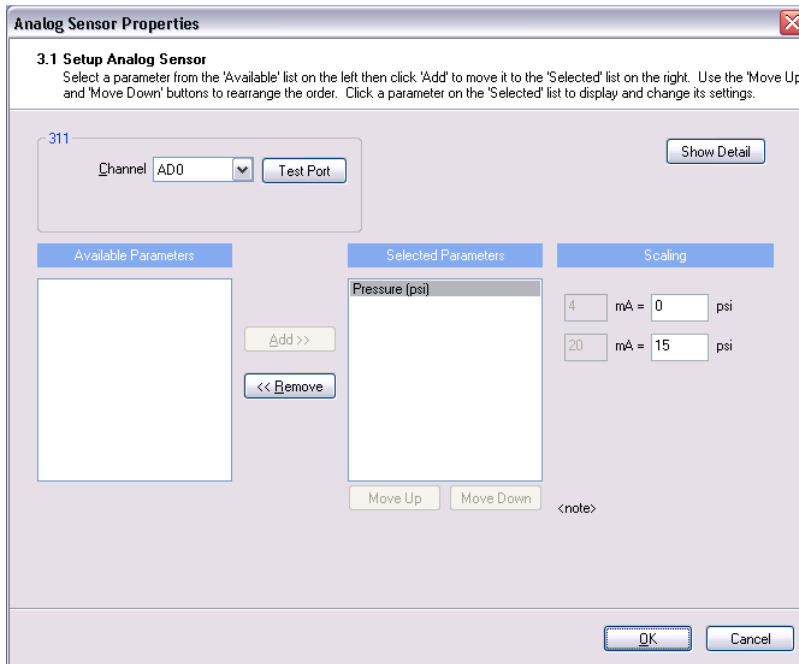

Model number **311-M351-xx**

<b>xx</b>	<b>Scaling</b>
PJ	20mA = 5 psi
PN	20mA = 10 psi
PP	20mA = 15 psi
PR	20mA = 20 psi
PO	20mA = 25 psi
PT	20mA = 30 psi
PV	20mA = 50 psi
PX	20mA = 75 psi
PZ	20mA = 100 psi
RB	20mA = 150 psi
RD	20mA = 200 psi
SZ	Custom

Click **OK** and the sensor will be added to the selected data logger. More sensors can be added at this time by selecting the sensor manufacturer and then sensor model number from the drop down menu on the right. Click **Next** when finished adding sensors.

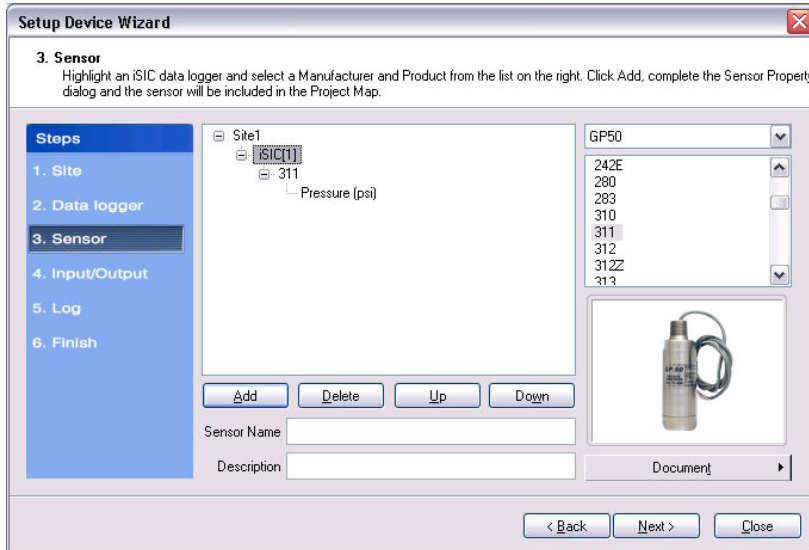

## Step 4 – Input/Output

Enable any output and control features of the data logger. See the iSIC manual, section **4.4.2 iSIC Controls** for more information on this functionality.

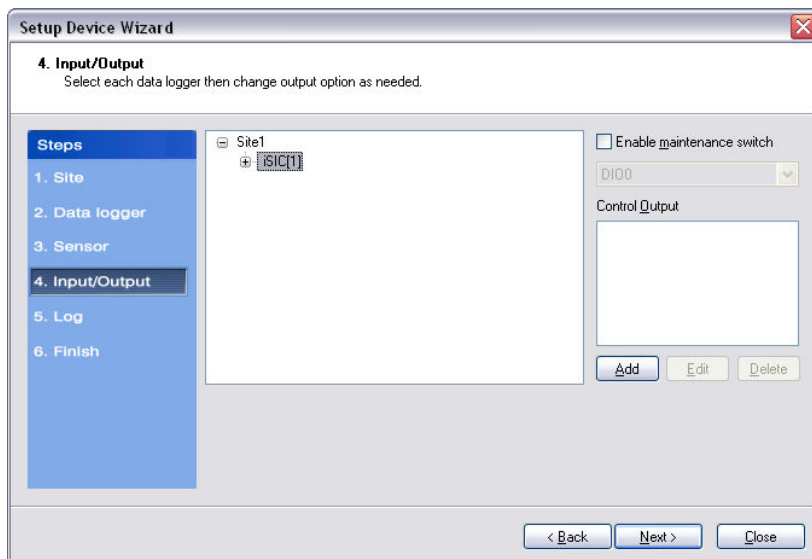

## Step 5 – Log

Select each data logger from the site list and enter the desired **Log Interval** and **Sample Interval** for the data logger in the **Interval** section. In the **Log Value** section, select how the data logger should log data points.

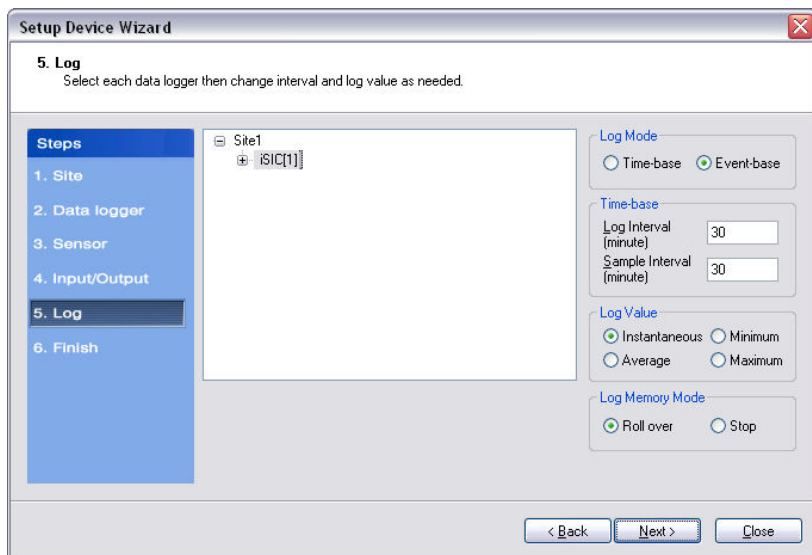

### Log Mode

The Log Mode controls when data is logged by an iSIC. In **Time-base** (the default and most common), data is logged at a specified interval, controlled in the **Time-base** section. In **Event-base** log mode, data is only logged when a ground pulse is sent to the Rain input pin on the iSIC digital terminal strip (such as from the contact closure of a tipping bucket rain gauge).

### Log Value

By default, the **Sample Interval** and **Log Interval** are equal. When a sampling interval is different than the log interval, all the sampled measurements for the iSIC are used to calculate the average, minimum, or maximum of that logging interval (based on the log type selected, only one can be selected at a time). The individual data points that comprise the samples are not saved; only the final, average, minimum or maximum data point is saved at the specified log interval.

### ***Log Memory Mode***

The default memory mode is **Roll over**, and is the recommended operating mode. In this mode, the last ~150K readings (when using 512K flash) will be stored in iSIC memory. When the iSIC memory has filled with readings it will “roll over” the original readings and keep logging. This is ideal for real time applications, where data is being uploaded to a PC as

In **Stop** memory mode, the first ~150K readings (when using 512K flash) will be stored in the iSIC memory. When the iSIC memory has filled with readings, it will stop logging until memory is cleared. When operating in this mode, it is recommended that memory is cleared every time data is uploaded.

## Step 6 – Finish

All data loggers and sensors must be programmed before data collection can begin.

- Select an iSIC data logger and click the '**Program iSIC**' button. Before programming an iSIC:
  - The iSIC must be powered and connected to the computer.
  - The 2100-iSIC must be powered and connected to a phone line.
  - The 3100-iSIC must be powered and have a cellular data account.
  - The 4100-iSIC must be powered and be able to communicate to the computer through a 4100-base or 4200-iSIC
  - The 5100-iSIC must be powered and be able to communicate to the computer over Ethernet.
- Click **Finish** when programming is complete.

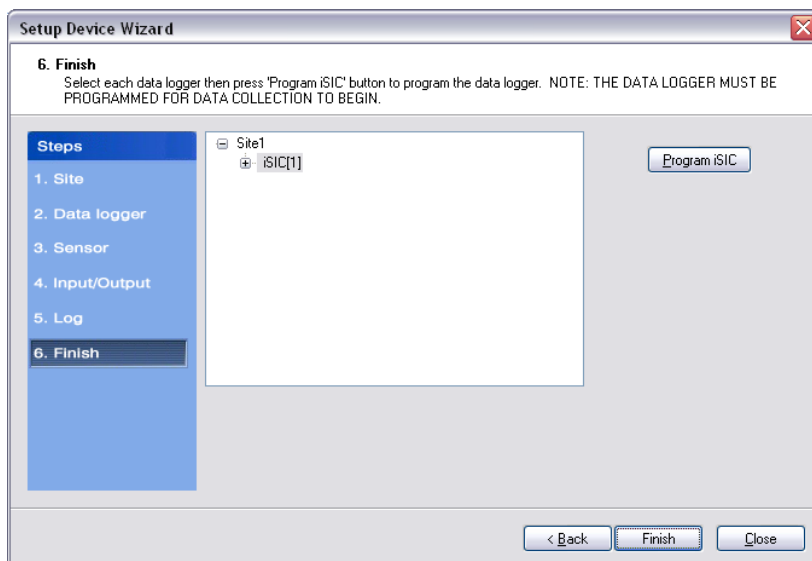

This wizard can always be revisited by selecting **Project | Setup Device Wizard** if you would like to program an iSIC at a later time or need to setup other sites, data loggers, and sensors.

## Step 7 – Retrieve an Initial Data Set and Use the Instrument Within iChart

After your sensor has been added to the database, the main instrument control screen will appear.

**Important:** All parameters are initially displayed with blank values until after the first log interval has passed and data has been interrogated. Once data has been retrieved from the iSIC, these fields will show the most recent data set recorded by the instrument. By default, iChart will automatically interrogate devices five minutes after every hour.